

 Scala a chiocciola disponibile con forma tonda o quadra;

Gradini in legno di faggio;

Palo centrale in metallo o legno (optional);

Ringhiera con colonne in acciaio verniciato;

Corrimano:

1. **FOX** in pvc effetto legno, tinta naturale o tinta noce, unico elemento continuo;
2. **FOX GREY** in pvc grigio, unico elemento continuo;
3. **FOX CL** in legno massiccio suddiviso in settori.

 Spiral staircase available with round or square shape;

Beech wood steps;

Central pole in metal or wood (optional);

Banister composed of painted steel columns;

Handrail:

1. **FOX** in wood-effect PVC, natural or walnut coloured, a single continuous element;
2. **FOX GREY** in grey PVC, single continuous element;
3. **FOX CL** made of solid wood divided into sectors.

 Escalier en colimaçon disponible ronde ou carrée ;

Marches en bois de hêtre ;

Poteau central en métal ou en bois (en option) ;

Rampe avec colonnes en acier vernissé;

Main courante:

1. **FOX** en PVC effet bois, couleur naturel ou noyer, un seul élément continu ;
2. **FOX GREY** en PVC gris, élément continu unique ;
3. **FOX CL** en bois massif divisé en secteurs.

 Spindeltreppe mit runder oder quadratischer Form erhältlich;

Stufen aus Buchenholz;

Zentralstange aus Metall oder Holz (optional);

Geländer mit lackierten Stahlsäulen;

Geländer:

1. **FOX** aus PVC in Holzoptik, Natur oder Nussbaumfarben, ein einziges durchgehendes Element;
2. **FOX GREY** aus grauem PVC, einzelnes durchgehendes Element;
3. **FOX CL** aus Massivholz, unterteilt in Sektoren.

 Escalera de caracol disponible con forma redonda o cuadrada;

Escalones de madera de haya;

Poste central en metal o madera (opcional);

Barandilla con columnas de acero pintado;

Barandilla:

1. **FOX** en PVC efecto madera, color natural o nogal, un único elemento continuo;
2. **FOX GRIS** en PVC gris, elemento continuo único;
3. **FOX CL** fabricado en madera maciza dividida en sectores.

Dettagli tecnici

Technical details - Détails techniques
Technische Details - Ficha técnica

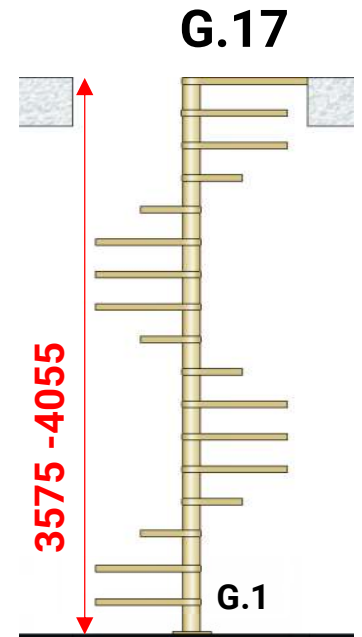
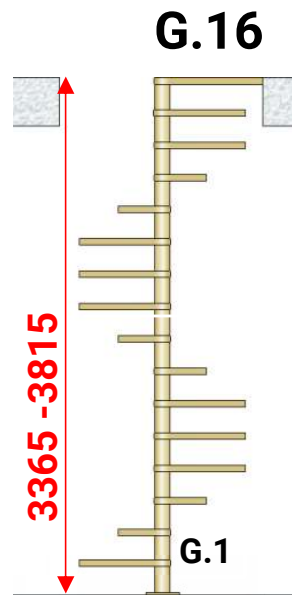
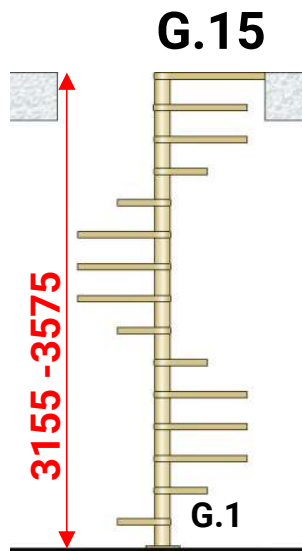
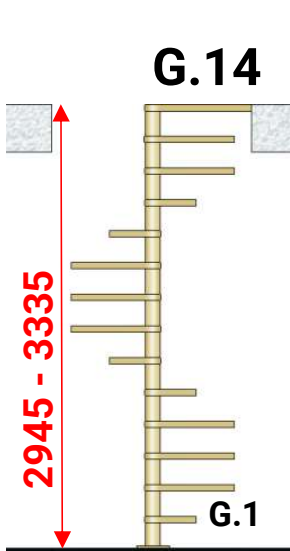
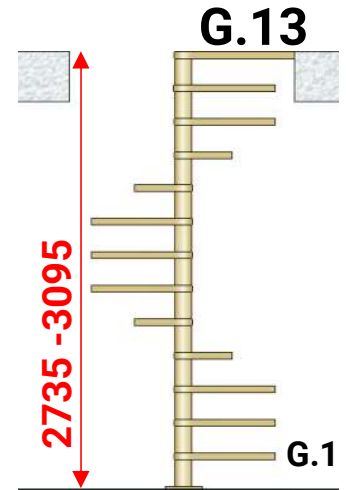
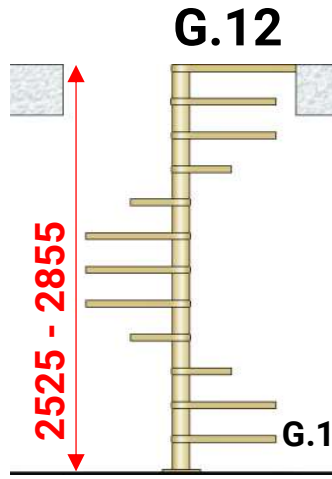
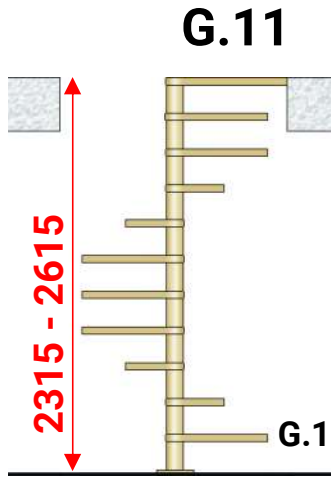

MIN 205 ÷ MAX 240

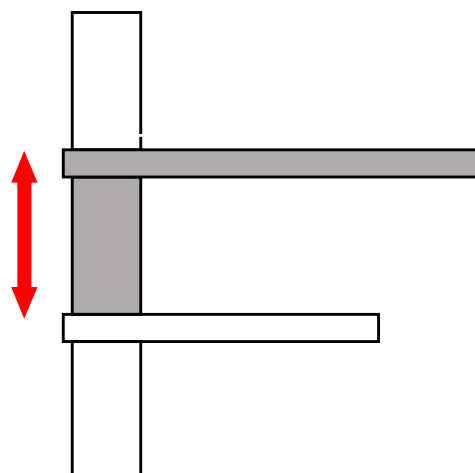

Dettagli tecnici Technical details - Détails techniques Technische Details - Ficha técnica

L	C1	C2	C3	P.U.	P.M.
Ø1100	622	729	601	430	144,9
Ø1200	675	787	649	480	157,9
Ø1300	722	846	696	530	170,8
Ø1400	773	904	743	580	165,7
Ø1500	823	962	791	630	177,4
Ø1600	873	1021	838	680	189,1

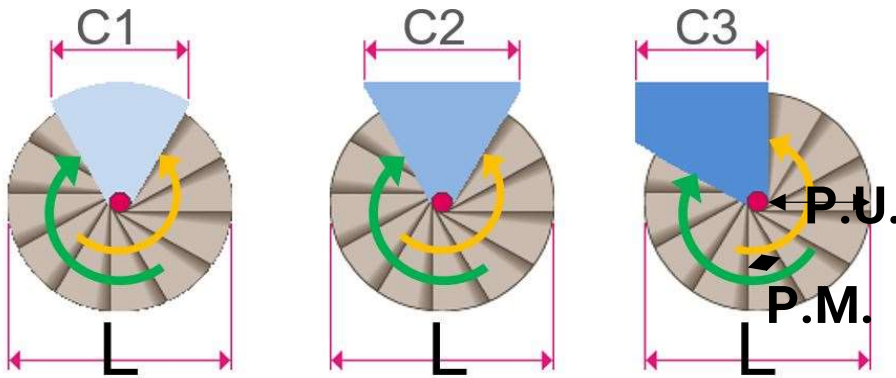
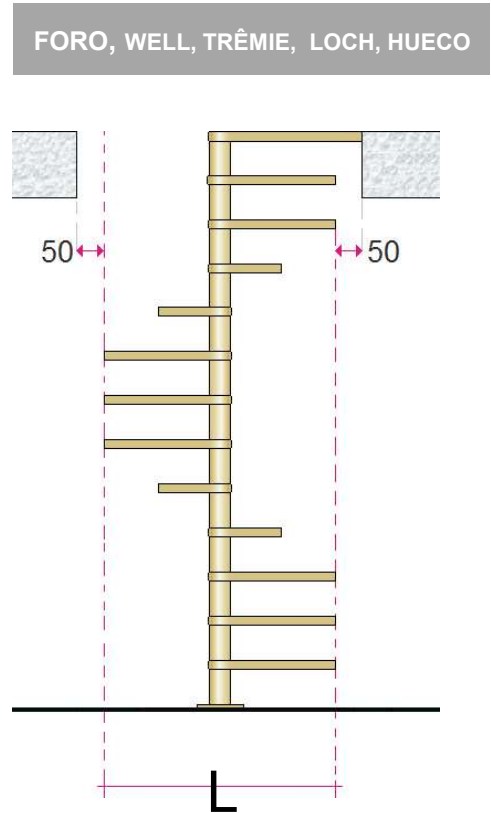

FISSAGGIO ARRIVO SBARCO, FIXING OF THE ARRIVAL LANDING, FIXATION DU PALIER D'ARRIVÉE, BEFESTIGUNG DES ANKUNFTSPODESTS

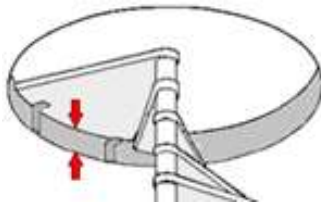

MIN 210

APERTURA GRADINI, TREADS OPENING, OUVERTURE DES MARCHES, ÖFFNUNG DER STUFEN, APERTURA DE LOS ESCALONES

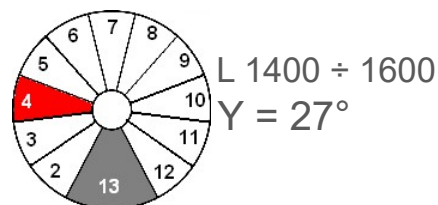
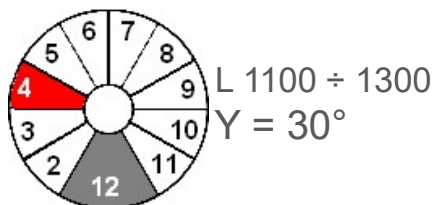

LEGNO, WOOD, BOIS, HOLZ, MADERA



Faggio
Beech
Hêtre
Buche
Haya

FOX T

Ø45 PVC effetto legno
 PVC wood effect
 PVC effet bois
 PVC-Holzoptik
 PVC efecto madera

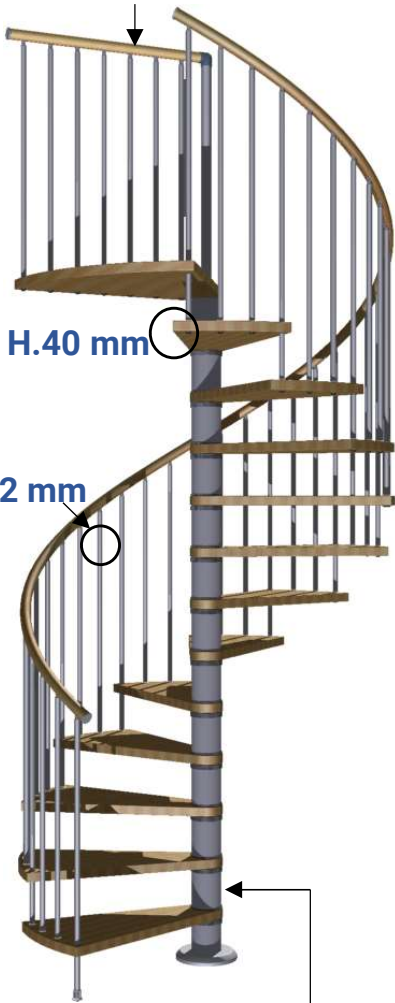

H.40 mm

Ø 22 mm

Metallo o legno – Ø127
 Metal or wood
 Métal ou bois
 Metall oder Holz
 Metal o madera

200 Kg/m²

FOX T GREY

Ø45 PVC grigio
 grey PVC
 gris PVC
 graues PVC
 PVC gris

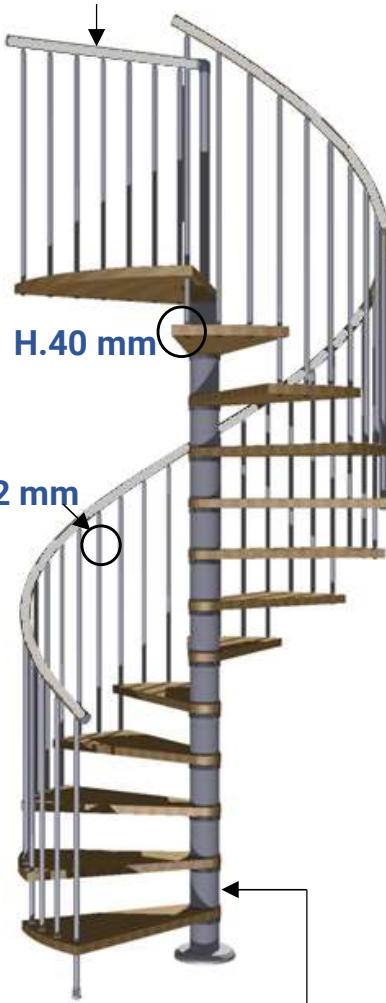

H.40 mm

Ø 22 mm

Metallo – Ø127
 Metal
 Métal
 Metall
 Metal

200 Kg/m²

FOX T CL

Ø45 Legno
 Wood
 Bois
 Holz
 Madera

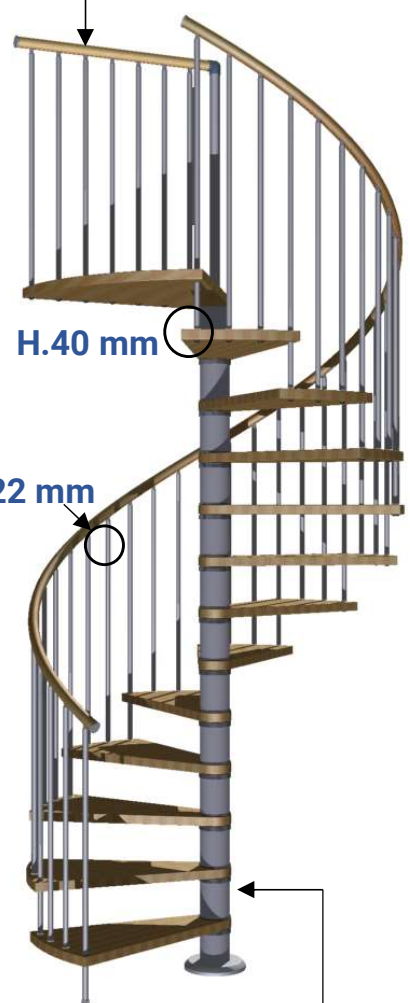

H.40 mm

Ø 22 mm

Metallo o legno – Ø127
 Metal or wood
 Métal ou bois
 Metall oder Holz
 Metal o madera

200 Kg/m²

Dettagli tecnici

Technical details - Détails techniques
Technische Details - Ficha técnica

L	C1	C2	C3	P.U.	P.M.
Ø1120	622	729	601	430	144,9
Ø1220	675	787	649	480	157,9
Ø1320	722	846	696	530	170,8
Ø1420	773	904	743	580	165,7
Ø1520	823	962	791	630	177,4
Ø1620	873	1021	838	680	189,1

FORO, WELL, TRÉMIE, LOCH, HUECO

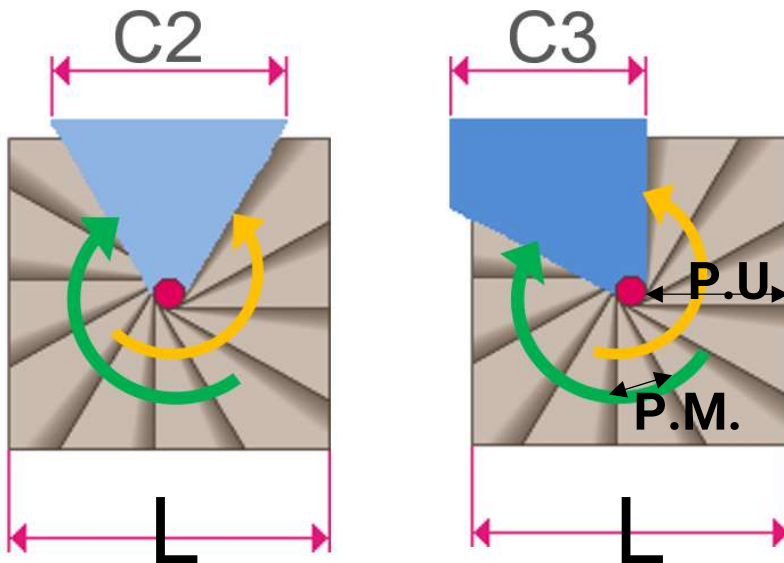
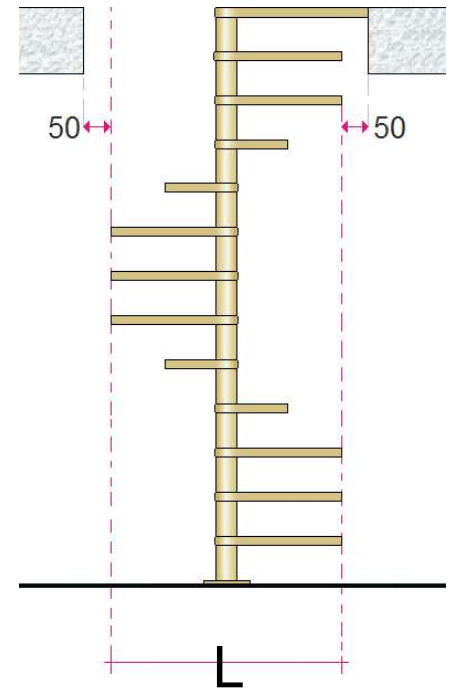

FISSAGGIO ARRIVO SBARCO, FIXING OF THE ARRIVAL LANDING, FIXATION DU PALIER D'ARRIVÉE, BEFESTIGUNG DES ANKUNFTSPODESTS

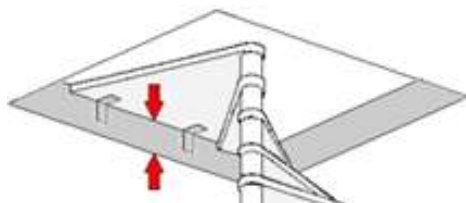

MIN 210

LEGNO, WOOD, BOIS, HOLZ, MADERA



Faggio
Beech
Hêtre
Buche
Haya

FOX Q

Ø45 PVC effetto legno
PVC wood effect
PVC effet bois
PVC-Holzoptik
PVC efecto madera

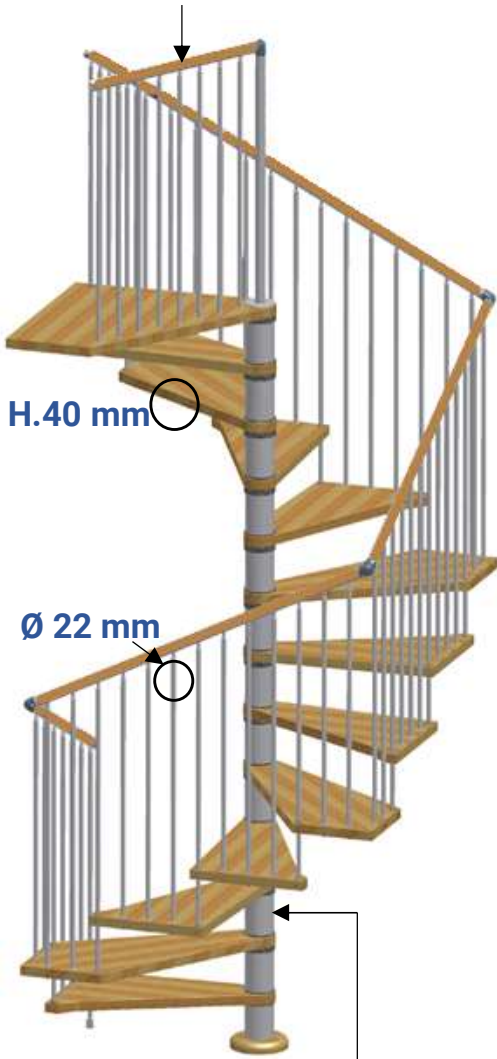

Metallo o legno – Ø127
Metal or wood
Métal ou bois
Metall oder Holz
Metal o madera

200 Kg/m²

FOX Q GREY

Ø45 PVC grigio
grey PVC
gris PVC
graus PVC
PVC gris



Metallo – Ø127
Metal
Métal
Metall
Metal

200 Kg/m²

FOX Q CL

Ø45 Legno
Wood
Bois
Holz
Madera

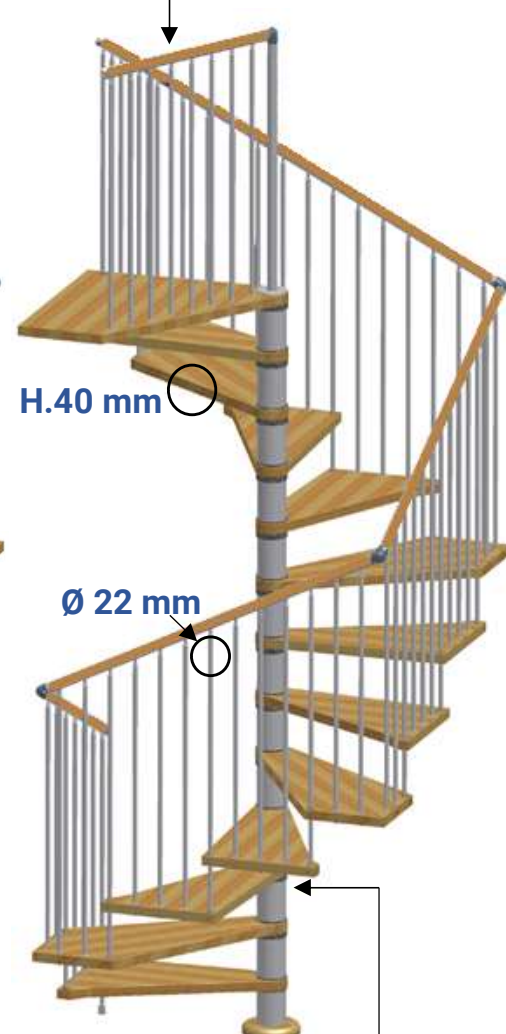

Metallo o legno – Ø127
Metal or wood
Métal ou bois
Metall oder Holz
Metal o madera

200 Kg/m²

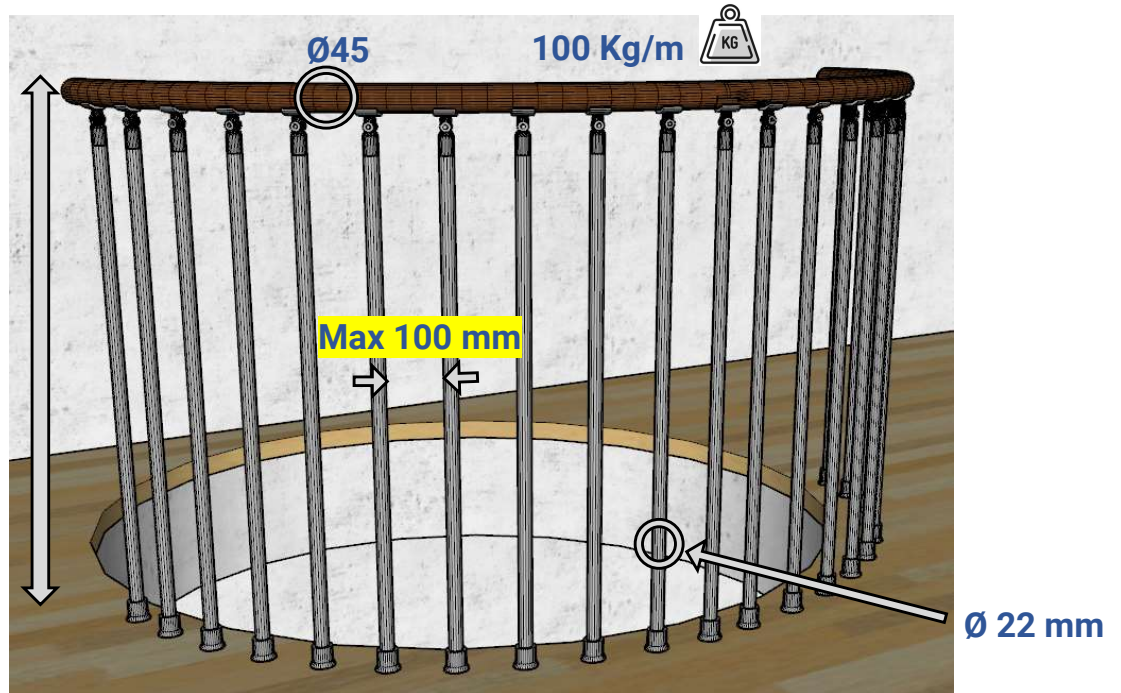
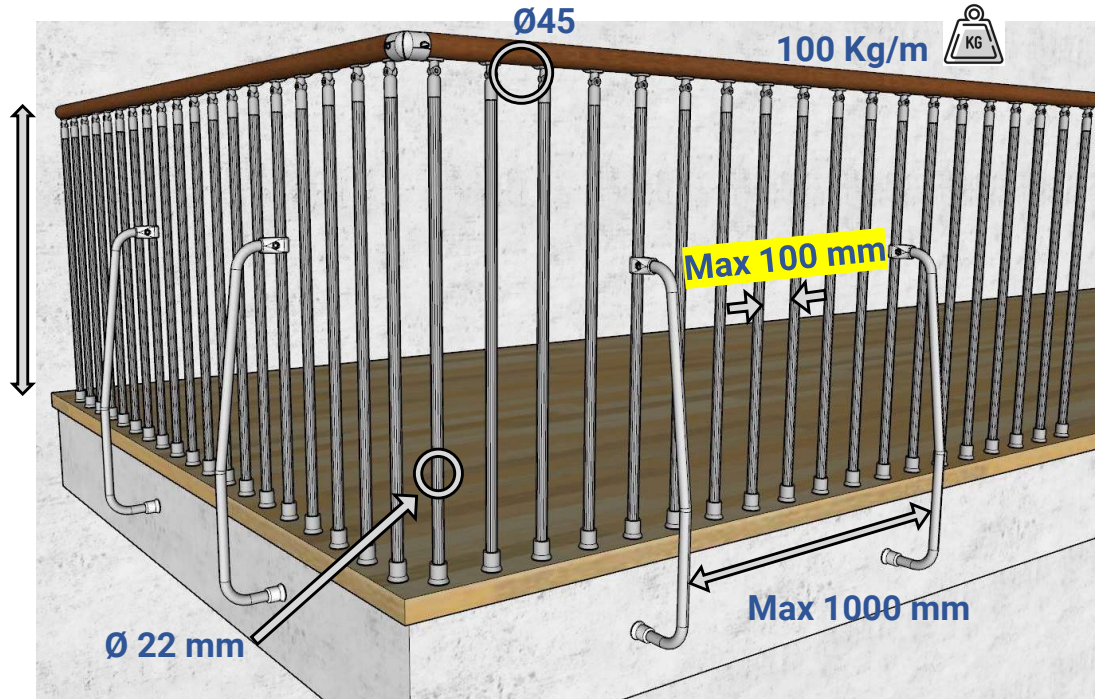

CORRIMANI - Handrails - Mains courantes – Handläufe - Barandillas



Ø45 PVC effetto legno
PVC wood effect
PVC effet bois
PVC-Holzoptik
PVC efecto madera



Ø45 PVC grigio
grey PVC
gris PVC
graues PVC
PVC gris

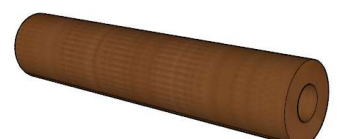

Ø45 Legno
Wood
Bois
Holz
Madera

Sbarco su misura

Landing on measure - Palier sur mesure
Podest nach Maß - Desembarco personalizado

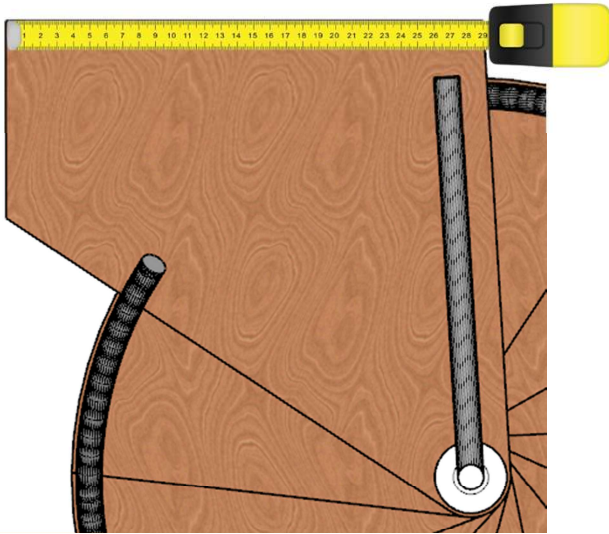

Corrimano a muro

Wall handrail - Main courante au mur
Wand-Handlauf, pasamanos de pared



Scala sovrapposta

Overlapping staircase - Escalier superposé,
überlagerte Treppe - Escalera superpuesta

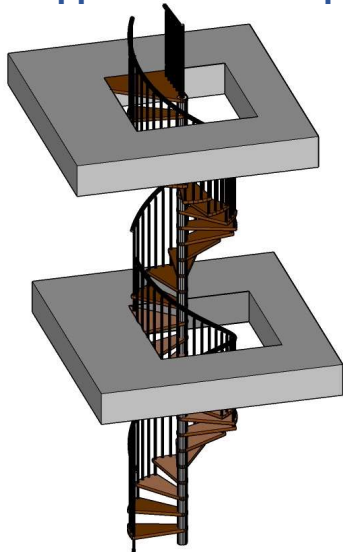

Piastra incollata

Glued Plate - Plaque collée - Geklebte Platte,
Placa encolada

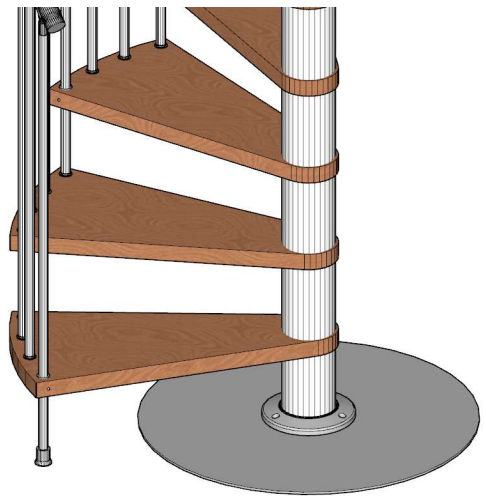

Pianerottolo tondo

Round landing - Palier ronde
Runde Podest - Desembarco redondo

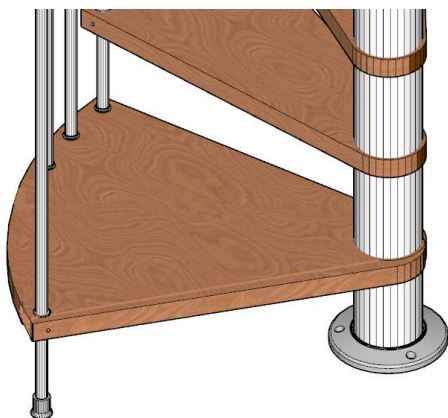

Pianerottolo quadro

Square landing - Palier carré
Viereckiges Podest - Desembarco cuadrado

